

agile

THE CONVENIENT SOLUTION
FOR YOUR BUSINESS

I LIKE
TO WORK
agile!



THE INNOVATIVE
PALLET TRUCK

 **Lifter**[®]
by PRAMAC

AGILE: THE INNOVATIVE SOLUTION COMBINING ELECTRIC AND MANUAL FUNCTION FOR CONVENIENT USABILITY.



COMPACT AND LIGHT

Ideal for use in any application where space and weight is critical.

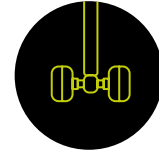

ELECTRONIC TRACTION CONTROL

Control to avoid wheel spinning and get the maximum in any situation (high torque for slopes, high speed for plane surface use).



FAST MANUAL LIFTING

Quicklift option enables you to lift the pallet in just two strokes.



KEY SWITCH

Pocket size key switch for every day practicality.

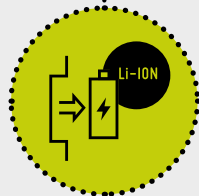

LI-ION BATTERY

Light battery easy to remove for recharging and continuous operation with spare battery.

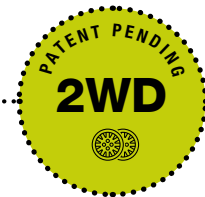

DOUBLE TRACTION WHEEL

The first pallet truck with 2 traction wheels in the market, for highest stability, better traction and durability.



HIGH SPEED

Fast and efficient motorised wheels, with reduced noise and easy maintenance.



NON-MARKING WHEELS

Durable rubber wheels which don't mark the surface.



The first motorized pallet truck with **two motor wheels** for better stability and traction. Compact, light, simple, **easy to use**.

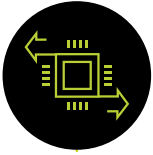

ON-BOARD COMPUTER

Front OLED display provides valuable info on truck activity and allows performance setup.



WEATHERPROOF OPTION

IP54 protection for outdoor use.

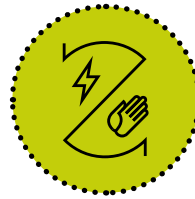

ELECTRIC/MANUAL SWITCH

Switching to manual mode enables to move easily in narrow space and in eventual case of low battery.

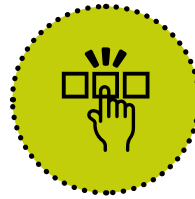

ALL FRAMES USE

Separate drive unit can be combined with frames of any size or metal.



ERGONOMIC TILLER

3D design, special coating, finger tip control for the most agile use in any situation.



LOW MAINTENANCE COST

Simple design with very few components and wiring enabling easy and fast maintenance.



1,2 TONS CAPACITY



AGILE IN EVERY SITUATION.

Compact as a standard HPT, it can be used across any site to make your job easier.



FAST AND EASY

The 2WD system makes the truck fast (5,3 km/h) and easy to drive, increasing safety and productivity.

Fingertip **electric/manual switch** makes the AGILE as a standard HPT.

POWERFUL AND STABLE

Thanks to the high torque and to the **2WD system**, loads up to 1,2 tons can be easily moved. Ideal for **loading/unloading** and everyday **last mile deliveries**.

Slopes and rough terrains become AGILE.



SILENT AND COMPACT

Reduced sound emissions (**AC motors**), compact size and small turning radius makes it an ideal product for mini markets and retail shops.

FAST RECHARGE CONTINUOUS RUNNING

Long life **Li-Ion battery technology** for occasional and fast charging (2 hours). Quick and easy charging process by simply removing the battery from the truck. This system allows extreme versatility and **continuous operation** (if using additional spare battery).

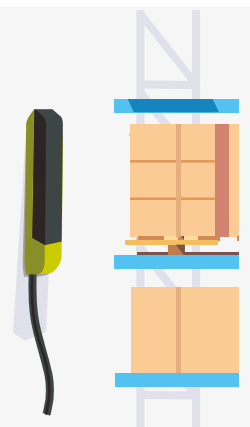

CONVENIENT FOR ALL.

USER ADVANTAGES

PERFORMANCE

1,2
TONS

CAPACITY
To cover all logistic needs.

5,3
Km/h

MAX SPEED
Fastest in the category.

86
KG

WEIGHT
Lightest in the category.

5
%

MAX GRADEABILITY FULL LOAD
Traction control to maximize torque on slopes.

1382
mm

TURNING RADIUS
Same as a HPT.



ELECTRIC/MANUAL SWITCH
Easy and versatile.

PATENT PENDING
2WD

DOUBLE TRACTION WHEEL SYSTEM

IP54

WEATHERPROOF VERSION
For outdoor use (option).

LONG LIFETIME LI-ION BATTERY SYSTEM

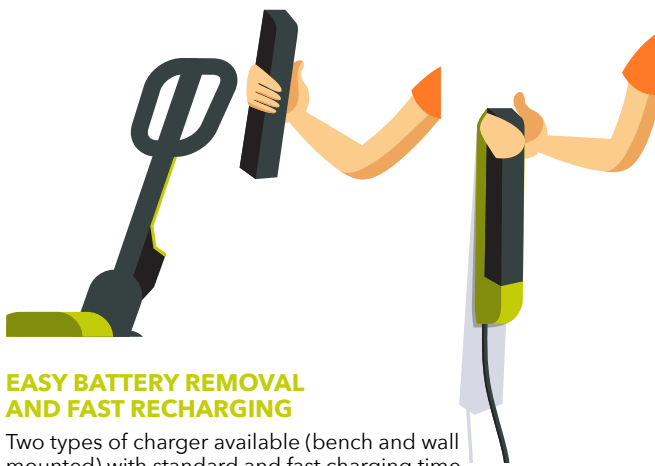

EASY BATTERY REMOVAL AND FAST RECHARGING

Two types of charger available (bench and wall mounted) with standard and fast charging time.

3
H

AUTONOMY
Continuous running with 600 kg average load at full speed.

2
H
FULL CHARGE

FAST AND OCCASIONAL RECHARGE

ECO-FRIENDLY

NO GAS EMISSION RECHARGE
Possibility to make it indoor in any place.

24/7

CONTINUOUS RUNNING
Using spare battery.

BUYER ADVANTAGES

HIGHEST ROI



- Lowest capital investment
- High productivity (fastest in the category)
- Low maintenance cost



SAFETY

- Manual running mode when needed
- Electric brake for slope use
- Emergency and belly buttons



HEALTH

- Reduces effort and improves health & safety in the work place

WIDE PRODUCT MODULARITY.

Two drive unit versions to cover any specific needs.

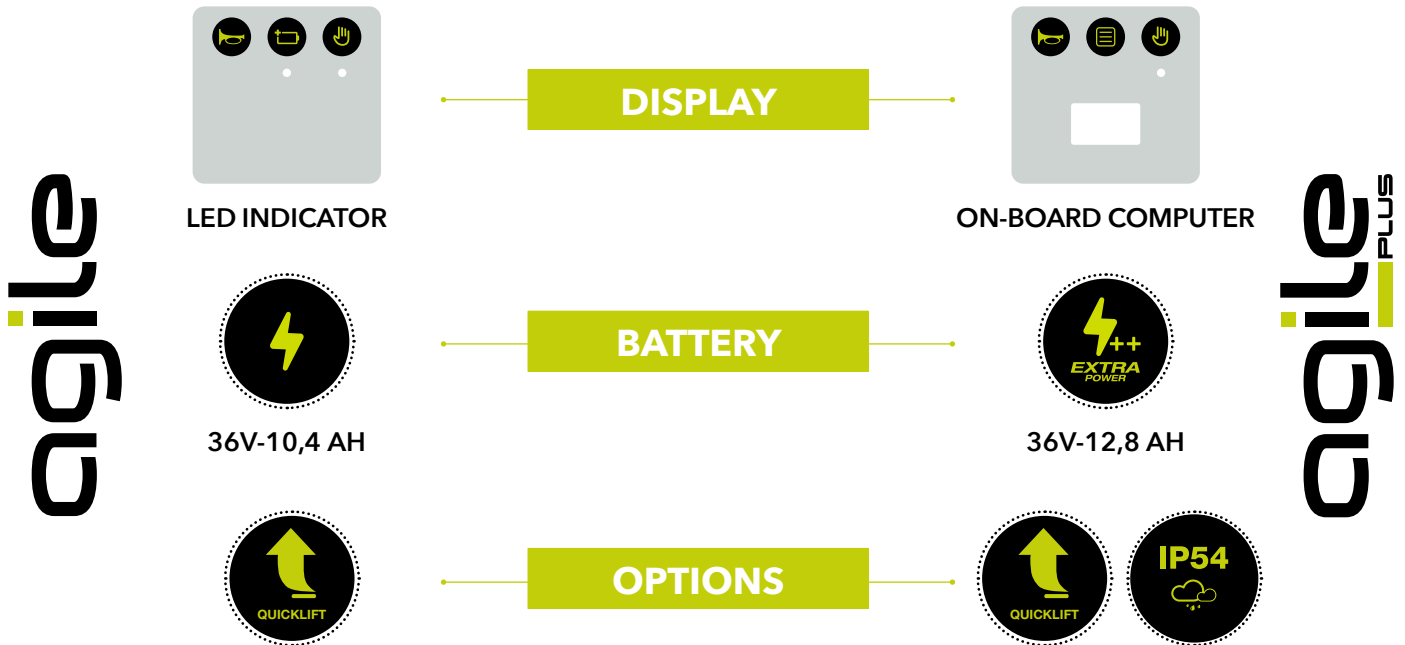

ON-BOARD COMPUTER WITH 6 SELECTABLE SCREENS

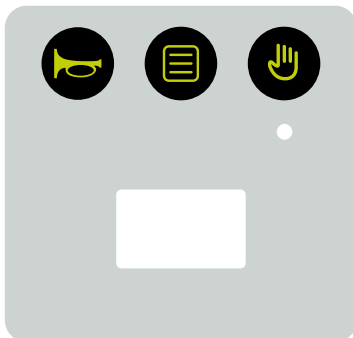

1. AUTONOMY

- 1.1 Battery status indicator (%)

2. HOURMETER

- 2.1 Partial working time meter (h)
- 2.2 Total working time meter (h)

3. DISTANCE

- 3.1 Trip distance (km)
- 3.2 Total distance (km)

4. MAX. SPEED SETTING

5. DIAGNOSTIC

6. ERROR

ALL DIFFERENT FRAMES TYPES AND FORK LENGTHS*

* Including Scale Pallet Truck

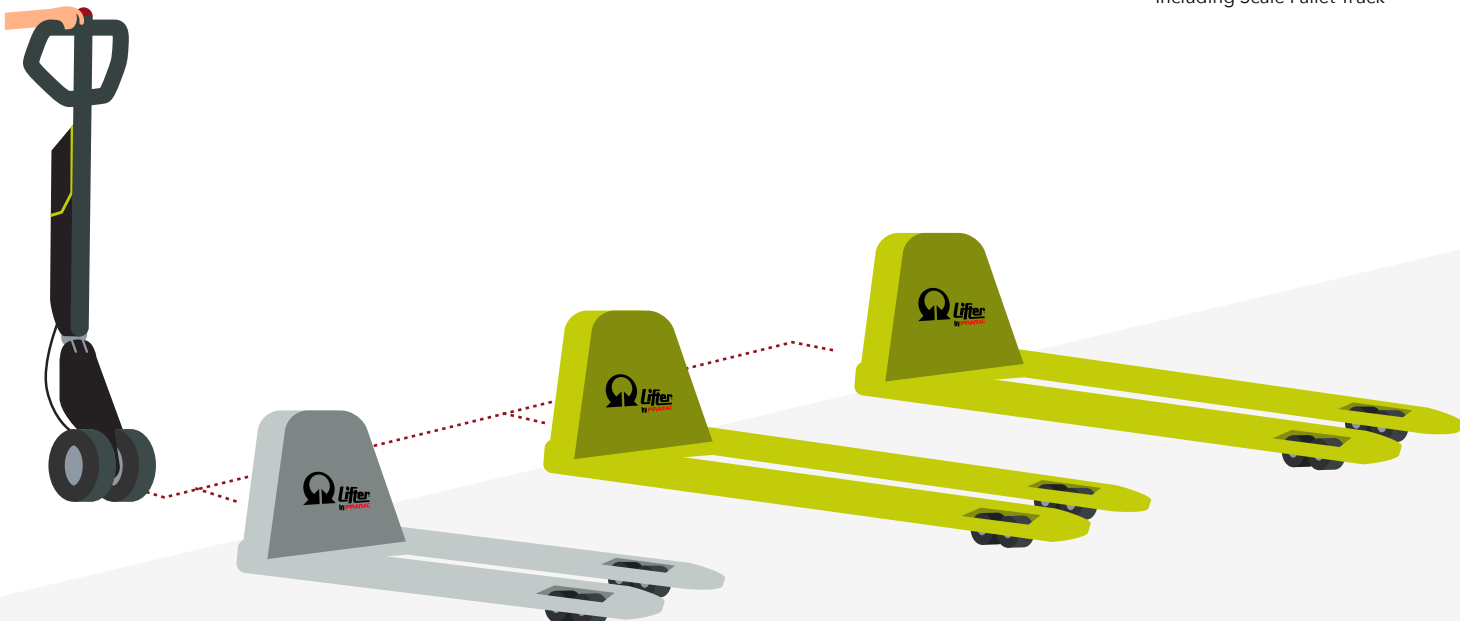

TECHNICAL SPECS.

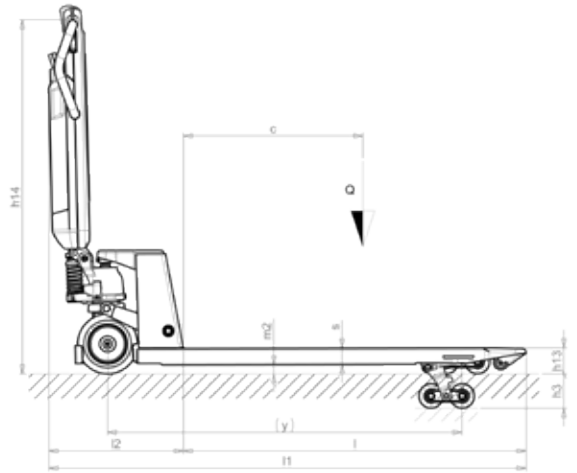
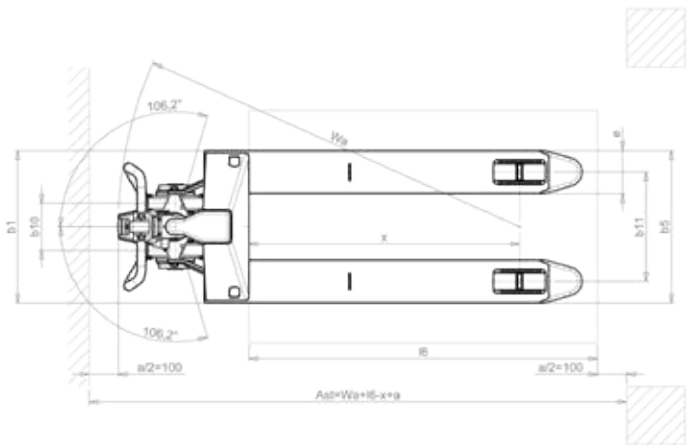

		agile	agile PLUS
DESCRIPTION			
1.2	MODEL	AGILE S2-S4	AGILE PLUS S2-S4
1.3	DRIVE	Electric	Electric
1.4	OPERATOR TYPE	Pedestrian	Pedestrian
1.5	LOAD CAPACITY	Q	Q
		kg	kg
		1200	1200
WEIGHT			
2.1	SERVICE WEIGHT	kg	kg
		86-88	86-88
TYRES/CHASSIS			
3.1	TYRES (FRONT - REAR)	Rubber - Poly	Rubber - Poly
3.2	TYRE SIZE, FRONT (Ø x width)	200x40	200x40
3.3	TYRE SIZE, REAR (Ø x width)	82x82-60	82x82-60
DIMENSIONS			
4.9	HEIGHT OF TILLER IN DRIVE POSITION MIN/MAX	h ₁₄	h ₁₄
		mm	mm
		710/1185	710/1185
4.19	OVERALL LENGTH	l ₁	l ₁
		mm	mm
		1600	1600
4.20	LENGHT TO FACE OF FORKS	l ₂	l ₂
		mm	mm
		450	450
4.22	FORK DIMENSIONS	s/e/l	s/e/l
		mm	mm
		55/150/1150	55/150/1150
4.25	DISTANCE BETWEEN FORK ARMS (MIN/MAX***)	b ₅	b ₅
		mm	mm
		525	525
4.34	AISLE WIDTH FOR PALLETS 800x1200 LENGHTWISE	A _{st}	A _{st}
		mm	mm
		2063	2063
4.35	TURNING RADIUS	W _a	W _a
		mm	mm
		1382	1382
PERFORMANCE DATA			
5.1	TRAVEL SPEED, LADEN/UNLADEN	km/h	km/h
		4,2/5,3	4,2/5,3
5.8	MAX GRADEABILITY, LADEN/UNLADEN	%	%
		5/15	5/15
5.10	SERVICE BRAKE	Electric	Electric
ELECTRIC MOTORS			
6.1	DRIVE MOTOR POWER	kW	kW
		2x0,25	2x0,25
6.4	BATTERY VOLTAGE, NOMINAL CAPACITY C5	V/Ah	V/Ah
		36/10,4	36/12,8
6.5	BATTERY WEIGHT	kg	kg
		3	3
8.4	SOUND LEVEL AT DRIVER'S EAR	dB(A)	dB(A)
		60	60

Powder Coated version, available in fork size (mm): 800x525, 950x525, 1000x525, 1150x525, 1220x525, 1350x525, 1500x525, 1800x525, 2000x525, 1000x685, 1150x685, 1220x685
 Galvanized version, available in fork size (mm): 800x525, 1000x525, 1150x525, 1220x685
 Scale version, available in fork size (mm): 1185x555



MADE IN ITALY

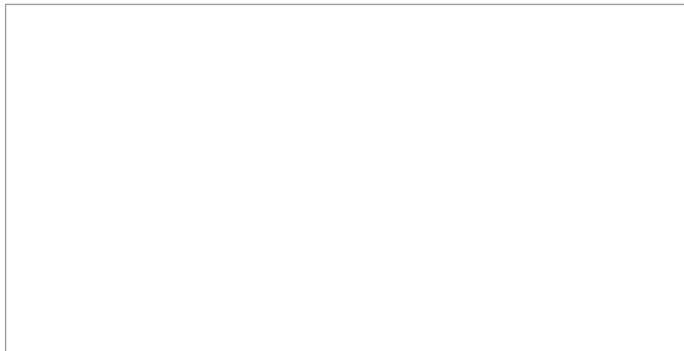

Pramac is a leading supplier of competitive material handling products, branded **Lifter by Pramac**, internationally recognized for its quality and performance.



www.lifter.it



Worldwide Service & Parts Online Center: www.pramacparts.com

PROJECT COORDINATION MKTG Department@PRAMAC

The product images shown are for illustration purposes only and may not be an exact representation of the product. The manufacturer reserves the right to introduce changes to models and features without prior notice.